

Pfaff 1426  
Subclass  
December 1989

The logo for CSMP (California State Music Project) is centered on the page. It features the letters 'CSMP' in a bold, stylized, sans-serif font. The letters are light gray and are enclosed within a larger, thin, light gray circular border that is not fully closed at the top and bottom.

1426

Unterklassen-Ausstattung  
Subclass parts  
Composition des sous-classes  
Composición de las subclases

Innovation made by **PFAFF**

## Erläuterungen Explanations

## Légende Explicaciones

Die Liste enthält nur Nähwerkzeuge sowie unterklassenabhängige Teile. Beim Umbau in eine andere Unterklasse bzw. Ausführung können auch noch Maschinenteile erforderlich sein. Geben Sie also bei Bestellungen die genaue Bezeichnung der vorhandenen bzw. der gewünschten Ausführung an.

The list contains only gauge parts and subclass-dependent parts. For a conversion into another subclass or version machine parts may be required as well. Please state the exact classification of the existing or required version on your order.

La liste comprend uniquement des organes de couture et des pièces dépendant des sous-classes. En cas de transformation en une autre sous-classe ou une autre version, il se peut que d'autres pièces de machine soient nécessaires. C'est pourquoi nous vous prions d'indiquer, à la commande, la désignation exacte de la version existante ou souhaitée.

La lista contiene solamente órganos de costura y piezas dependientes de la subclase. En el caso de transformación en otra subclase o en otro tipo, es posible que sean necesarias piezas de la máquina. Al hacer los pedidos, indíquese la denominación exacta del tipo existente o del deseado.

- 3/1 Gesichert mit Loctite.  
Secured with Loctite.  
Bloqué par Loctite.  
Asegurado con Loctite.
- 4 Ausführungsart bei Bestellung angeben.  
Model to be stated on order.  
Préciser le modèle à la commande.  
Indíquese el tipo en los pedidos.
- 5 Nähmuster bzw. Material einsenden.  
Submit sewing sample or material.  
Joindre échantillons de couture ou matières.  
Enviense muestras de costura.
- 10 Nadelabstand  
Needle gauge  
Ecartement des aiguilles  
Distancia entre agujas
- 10/1 Je nach Nadelabstand ändert sich die Form (z.B. beim Stoffschieber die Anzahl der Zahnreihen).  
Certain design features change according to the needle gauge (e.g. the number of tooth rows on the feed dog).  
La forme est fonction de l'écartement des aiguilles (par ex. le nombre des rangées de dents de la griffe).  
La forma varia de acuerdo con la distancia entre agujas (p.e. el número de hileras de dientes en el transportador).
- 10/2 Nadelabstand bei Bestellung angeben.  
Needle gauge to be stated on order.  
Ecartement des aiguilles; à préciser à la commande.  
Indíquese en los pedidos la distancia entre agujas.

**Unterklassen-Übersicht**  
**Table of subclasses**

**Table des sous-classes**  
**Tabla de subclasses**

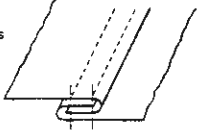
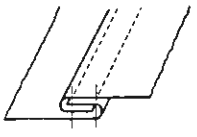
Unterklasse Subclass Sous-classe Subclase	-6/01 (-900/..)	-6/07 (-900/..)	-57/01 (-900/..)	-58/01 (-900/..)
Arbeitsgang Operation Opération Operación	Für allgemeine Näharbeiten. Standardform des Teilesatzes. For ordinary sewing operations. Standard parts set. Travaux d'utilité courante. Jeu de pièces standard. Para trabajos de costura en general. Juego de piezas estándar.	Für Nähte mit Übergängen (Klettteilersatz). For seams involving cross seams (climbing parts set). Couture de matières à surépaisseurs (pied grim pant). Para costuras con desniveles (juego de piezas trepador).		
Ausführung Model Version Tipo de máquina	BN: CN	BN: CN	BN: CN	BN: CN
Nadelabstand in mm Needle gauge in mm Ecartement des aiguilles en mm Distancia entre agujas en mm	2,4 - 34,0	2,4 - 24,0	4,8 - 20,0	4,8 - 20,0
Nadelhalter $\frac{10}{2}$ Needle holder Pince-aiguille Portaagujas	91-176 068-93 $\frac{10}{1}$ = 2,4 - 4,4 mm 91-172 590-93 $\frac{10}{1}$ = 4,8 - 7,6 mm 91-172 840-93 $\frac{10}{1}$ = 8,0 - 34,0 mm	91-176 068-93 $\frac{10}{1}$ = 2,4 - 4,4 mm 91-172 590-93 $\frac{10}{1}$ = 4,8 - 7,6 mm 91-172 840-93 $\frac{10}{1}$ = 8,0 - 24,0 mm	91-172 590-93 $\frac{10}{1}$ = 4,8 - 7,6 mm 91-172 840-93 $\frac{10}{1}$ = 8,0 - 20,0 mm	91-172 590-93 $\frac{10}{1}$ = 4,8 - 7,6 mm 91-172 840-93 $\frac{10}{1}$ = 8,0 - 20,0 mm
Stoffschieber $\frac{4}{1}$ $\frac{10}{1}$ $\frac{10}{2}$ Feed dog Griffe Transportador inferior	91-059 647-04	91-059 647-04	91-059 647-04	91-059 647-04
Stichplatte $\frac{4}{1}$ $\frac{10}{1}$ $\frac{10}{2}$ Needle plate Plaque à aiguille Placa de aguja	91-150 155-04	91-150 155-04	91-150 155-04	91-150 155-04
Stoffdrückerfuß $\frac{4}{1}$ $\frac{10}{2}$ Presser foot Pied presseur Pie prensatelas	91-049 801-93	91-049 772-93	91-049 801-93	91-049 801-93
Stoffschiebefuß $\frac{4}{1}$ $\frac{10}{2}$ Vibrating presser Pied entraîneur Transportador superior	91-049 385-93	91-049 385-93	91-049 385-93	91-049 385-93
Apparat $\frac{3}{1}$ $\frac{10}{2}$ Attachment Appareil Aparato			91-040 317-93 $\frac{10}{1}$ = 4,8 - 10,0 mm 91-042 068-24 $\frac{10}{1}$ = 11,2 - 20,0 mm	91-040 316-93 $\frac{10}{1}$ = 4,8 - 10,0 mm 91-040 814-24 $\frac{10}{1}$ = 11,2 - 20,0 mm
Fingerschutz $\frac{10}{2}$ Finger guard Protège-doigts Salvadedos	91-155 422-91 $\frac{10}{1}$ = 2,4 - 4,4 mm 91-057 707-91 $\frac{10}{1}$ = 4,8 - 15,2 mm 91-057 710-91 $\frac{10}{1}$ = 16,0 - 30,0 mm 91-057 712-91 $\frac{10}{1}$ = 32,0 - 34,0 mm	91-155 422-91 $\frac{10}{1}$ = 2,4 - 4,4 mm 91-057 707-91 $\frac{10}{1}$ = 4,8 - 15,2 mm 91-057 710-91 $\frac{10}{1}$ = 16,0 - 24,0 mm	91-057 707-91 $\frac{10}{1}$ = 4,8 - 15,2 mm 91-057 710-91 $\frac{10}{1}$ = 16,0 - 20,0 mm	91-057 707-91 $\frac{10}{1}$ = 4,8 - 15,2 mm 91-057 710-91 $\frac{10}{1}$ = 16,0 - 20,0 mm

**Unterklassen-Übersicht**  
Table of subclasses

**Table des sous-classes**  
Tabla de subclasses

Unterklasse Subclass Sous-classe Subclase	-68/97 (-900/..)	-68/99 (-900/..)	-147/02 (-900/..)
Arbeitsgang Operation Opération Operación			
Ausführung Model Version Tipo de máquina	BN; CN	BN; CN	BN; CN
Nadelabstand in mm Needle gauge in mm Ecartement des aiguilles en mm Distancia entre agujas en mm	16,0 - 24,0	16,0 - 24,0	4,0 - 20,0
Nadelhalter <sup>10/2</sup> Needle holder Pince-aiguille Portaagujas	91-172 840-93	91-172 840-93	91-176 068-93 <sup>10</sup> = 4,0 - 4,4 mm 91-172 590-93 <sup>10</sup> = 4,8 - 7,6 mm 91-172 840-93 <sup>10</sup> = 8,0 - 20,0 mm
Stoffschieber <sup>4</sup> <sup>10/1</sup> <sup>10/2</sup> Feed dog Griffe Transportador inferior	91-059 647-04	91-059 647-04	91-059 647-04
Stichplatte <sup>4</sup> <sup>10/1</sup> <sup>10/2</sup> Needle plate Plaque à aiguille Placa de aguja	91-150 155-04	91-150 155-04	91-150 155-04
Stoffdrückertuß <sup>4</sup> <sup>10/2</sup> Presser foot Pied presseur Pie prensatelas	91-049 829-93	91-049 829-93	91-049 801-93
Stoffschiebefuß <sup>3</sup> <sup>10/2</sup> Vibrating presser Pied entraîneur Transportador superior	91-049 436-93	91-049 436-93	91-049 385-93
Apparat <sup>5</sup> <sup>10/2</sup> Attachment Appareil Aparato	99-117 944-23	99-116 630-23	91-053 679-25
Träger Bracket Support Soporte			91-753 936-90
Fingerschutz <sup>10/2</sup> Finger guard Protège-doigts Salvadedos			91-155 429-91 <sup>10</sup> = 4,0 - 6,4 mm 91-057 707-91 <sup>10</sup> = 6,8 - 15,2 mm 91-057 710-91 <sup>10</sup> = 16,0 - 20,0 mm





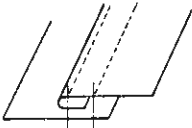
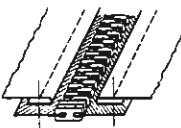
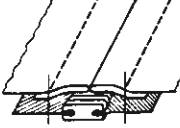
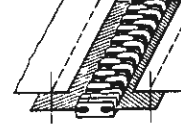







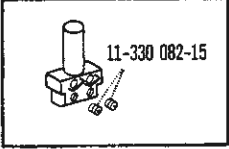



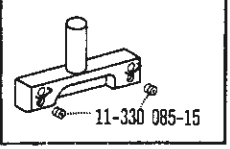



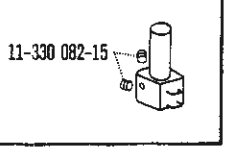



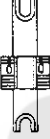















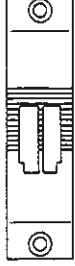



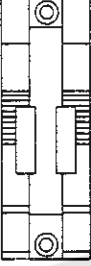

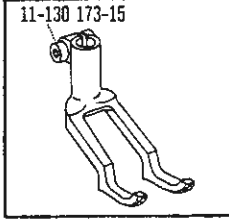
**Unterklassen-Übersicht**  
**Table of subclasses**

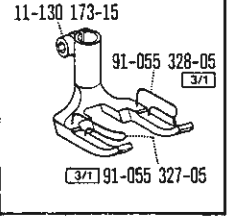
**Table des sous-classes**  
**Tabla de subclasses**

Unterklasse Subclass Sous-classe Subclase	-148/02 (-900/..)	-230/01 (-900/..)	-230/21 (-900/..)	-237/01 (-900/..)
Arbeitsgang Operation Operation Operacion				
Ausführung Model Version Tipo de máquina	BN; CN	BN; CN	BN; CN	BN; CN
Nadelabstand in mm Needle gauge in mm Ecartement des aiguilles en mm Distancia entre agujas en mm	4,0 - 20,0	8,0 - 20,0	8,0 - 20,0	8,0 - 20,0
Nadelhalter <u>10/2</u> Needle holder Pince-aiguille Portaagujas	91-176 068-93 <u>10</u> = 4,0 - 4,4 mm 91-172 590-93 <u>10</u> = 4,8 - 7,6 mm 91-172 840-93 <u>10</u> = 8,0 - 20,0 mm	91-172 840-93	91-172 840-93	91-172 840-93
Stoffschieber <u>4</u> <u>10/1</u> <u>10/2</u> Feed dog Griffe Transportador inferior	91-059 647-04	91-059 304-04	91-059 304-04	91-059 304-04
Stichplatte <u>4</u> <u>10/1</u> <u>10/2</u> Needle plate Plaque à aiguille Placa de aguja	91-150 155-04	91-150 187-04	91-150 187-04	91-150 187-04
Stoffdrückfuß <u>4</u> <u>10/2</u> Presser foot Pied presseur Pie prensateelas	91-049 801-93	91-049 775-93	91-049 775-93	91-049 775-93
Stoffschiebefuß <u>4</u> <u>10/2</u> Vibrating presser Pied entraîneur Transportador superior	91-049 385-93	91-049 387-93	91-049 387-93	91-049 387-93
Apparat <u>5</u> <u>10/2</u> Attachment Appareil Aparato	91-042 589-23	91-156 264-73	91-156 268-73	91-156 277-71/995
Träger Bracket Support Soporte	91-753 936-90			
Fingerschutz <u>10/2</u> Finger guard Protège-doigts Salvadedos	91-155 429-91 <u>10</u> = 4,0 - 6,4 mm 91-057 707-91 <u>10</u> = 6,8 - 15,2 mm 91-057 710-91 <u>10</u> = 16,0 - 20,0 mm			

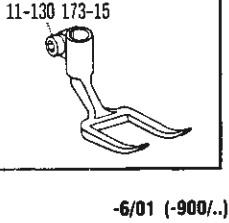
**Nähwerkzeuge  
Gauge parts**

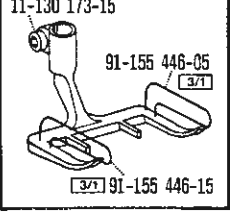
**Organes de couture  
Organos de costura**

<p>91-172 590-93  </p>  <p>11-330 082-15</p> <p> = 4,8 - 7,6 mm</p> <ul style="list-style-type: none"> <li>-6/01 (-900/..)</li> <li>-6/07 (-900/..)</li> <li>-57/01 (-900/..)</li> <li>-58/01 (-900/..)</li> <li>-147/02 (-900/..)</li> <li>-148/02 (-900/..)</li> </ul>	<p>91-172 840-93  </p>  <p>11-330 085-15</p> <p> = 8,0 - 34,0 mm</p> <ul style="list-style-type: none"> <li>-68/99 (-900/..)</li> <li>-6/01 (-900/..)</li> <li>-6/07 (-900/..)</li> <li>-57/01 (-900/..)</li> <li>-58/01 (-900/..)</li> <li>-68/97 (-900/..)</li> <li>-147/02 (-900/..)</li> <li>-148/02 (-900/..)</li> <li>-230/01 (-900/..)</li> <li>-230/21 (-900/..)</li> <li>-237/01 (-900/..)</li> </ul>	<p>91-176 068-93  </p>  <p>11-330 082-15</p> <p> = 2,4 - 4,4 mm</p> <ul style="list-style-type: none"> <li>-6/01 (-900/..)</li> <li>-6/07 (-900/..)</li> <li>-147/02 (-900/..)</li> <li>-148/02 (-900/..)</li> </ul>	
<p>91-059 304-04  </p>  <ul style="list-style-type: none"> <li>-230/01 (-900/..)</li> <li>-230/21 (-900/..)</li> <li>-237/01 (-900/..)</li> </ul>	<p>91-059 647-04  </p>  <p> = 2,4 - 4,0 mm</p> <ul style="list-style-type: none"> <li>-6/01 (-900/..)</li> <li>-6/07 (-900/..)</li> <li>-147/02 (-900/..)</li> <li>-148/02 (-900/..)</li> </ul>	<p>91-059 647-04   </p>  <p> = 4,8 - 34,0 mm</p> <ul style="list-style-type: none"> <li>-6/01 (-900/..)</li> <li>-6/07 (-900/..)</li> <li>-57/01 (-900/..)</li> <li>-58/01 (-900/..)</li> <li>-68/97 (-900/..)</li> <li>-68/99 (-900/..)</li> <li>-147/02 (-900/..)</li> <li>-148/02 (-900/..)</li> </ul>	
<p>91-150 155-04  </p>  <p> = 2,4 - 4,0 mm</p> <ul style="list-style-type: none"> <li>-6/01 (-900/..)</li> <li>-6/07 (-900/..)</li> <li>-147/02 (-900/..)</li> <li>-148/02 (-900/..)</li> </ul>	<p>91-150 155-04   </p>  <p> = 4,8 - 34,0 mm</p> <ul style="list-style-type: none"> <li>-6/01 (-900/..)</li> <li>-6/07 (-900/..)</li> <li>-57/01 (-900/..)</li> <li>-58/01 (-900/..)</li> <li>-68/97 (-900/..)</li> <li>-68/99 (-900/..)</li> <li>-147/02 (-900/..)</li> <li>-148/02 (-900/..)</li> </ul>	<p>91-150 187-04  </p>  <ul style="list-style-type: none"> <li>-230/01 (-900/..)</li> <li>-230/21 (-900/..)</li> <li>-237/01 (-900/..)</li> </ul>	
<p>91-049 772-93  </p>  <p>11-130 173-15</p> <ul style="list-style-type: none"> <li>-6/07 (-900/..)</li> </ul>	<p>91-049 775-93  </p>  <p>11-130 173-15</p> <p>91-055 328-05 </p> <p> 91-055 327-05</p> <ul style="list-style-type: none"> <li>-230/01 (-900/..)</li> <li>-230/21 (-900/..)</li> <li>-237/01 (-900/..)</li> </ul>	<p>91-049 801-93  </p>  <p>11-130 173-15</p> <ul style="list-style-type: none"> <li>-6/01 (-900/..)</li> <li>-57/01 (-900/..)</li> <li>-58/01 (-900/..)</li> <li>-147/02 (-900/..)</li> <li>-148/02 (-900/..)</li> </ul>	<p>91-049 829-93  </p>  <p>11-130 173-15</p> <p>91-155 446-05 </p> <p> 91-155 446-15</p> <ul style="list-style-type: none"> <li>-68/97 (-900/..)</li> <li>-68/99 (-900/..)</li> </ul>

Nähwerkzeuge  
Gauge parts

Organes de couture  
Organos de costura

91-049 385-93 [4] [10/2]

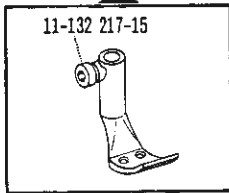

11-132 217-15  
-6/01 (-900/..)  
-6/07 (-900/..)  
-57/01 (-900/..)  
-58/01 (-900/..)  
-147/02 (-900/..)  
-148/02 (-900/..)

91-049 387-93 [4] [10/2]

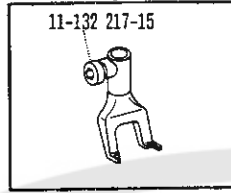

11-132 217-15  
-230/01 (-900/..)  
-230/21 (-900/..)  
-237/01 (-900/..)

91-049 436-93 [4] [10/2]

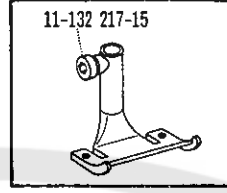

11-132 217-15  
-68/97 (-900/..)  
-68/99 (-900/..)

91-700 799-15 [5] [10/2]

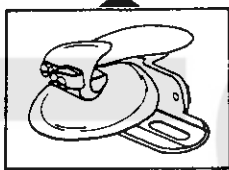

91-040 316-93 [5] [10/2]  
[10] = 4,8 - 10,0 mm

-58/01 (-900/..)

91-700 799-15 [5] [10/2]

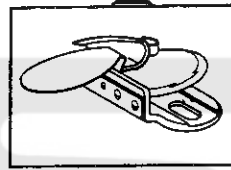

91-040 317-93 [5] [10/2]  
[10] = 4,8 - 10,0 mm

-57/01 (-900/..)

91-700 799-15 [5] [10/2]

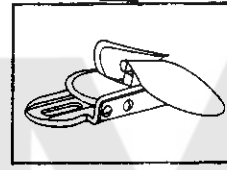

91-040 814-24 [5] [10/2]  
[10] = 11,2 - 20,0 mm

-58/01 (-900/..)

91-700 799-15 [5] [10/2]

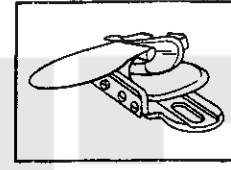

91-042 066-24 [5] [10/2]  
[10] = 11,2 - 20,0 mm

-57/01 (-900/..)

91-042 589-23 [5] [10/2]

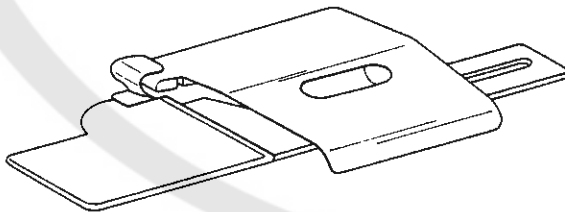

-148/02 (-900/..)

91-053 679-25 [5] [10/2]

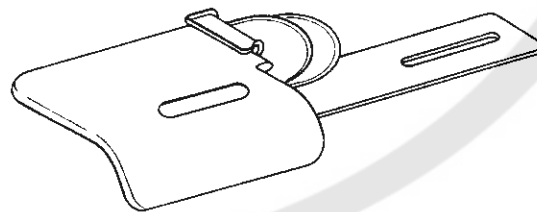

-147/02 (-900/..)

91-156 264-73 [5] [10/2]

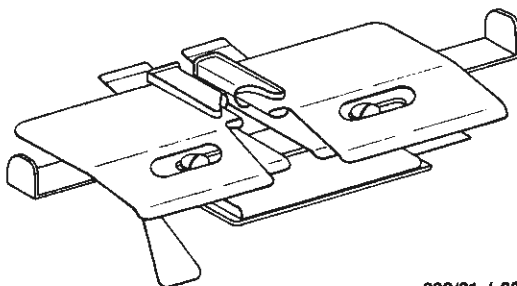

-230/01 (-900/..)

91-156 268-73 [5] [10/2]

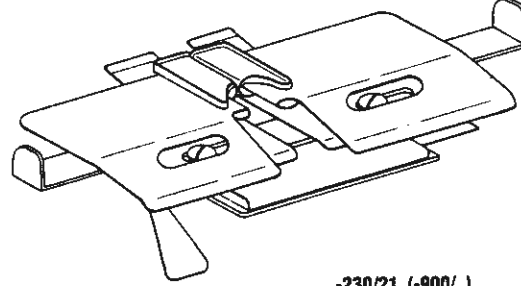

-230/21 (-900/..)



Nähwerkzeuge  
Gauge parts

Organes de couture  
Organos de costura

91-156 277-71/995  10/2

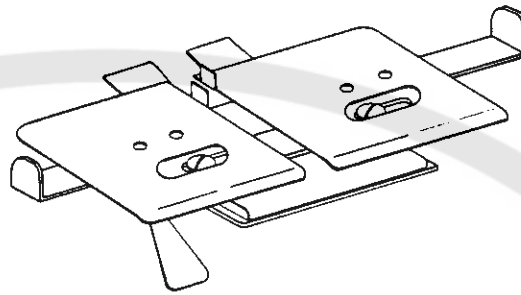

-237/01 (-900/..)

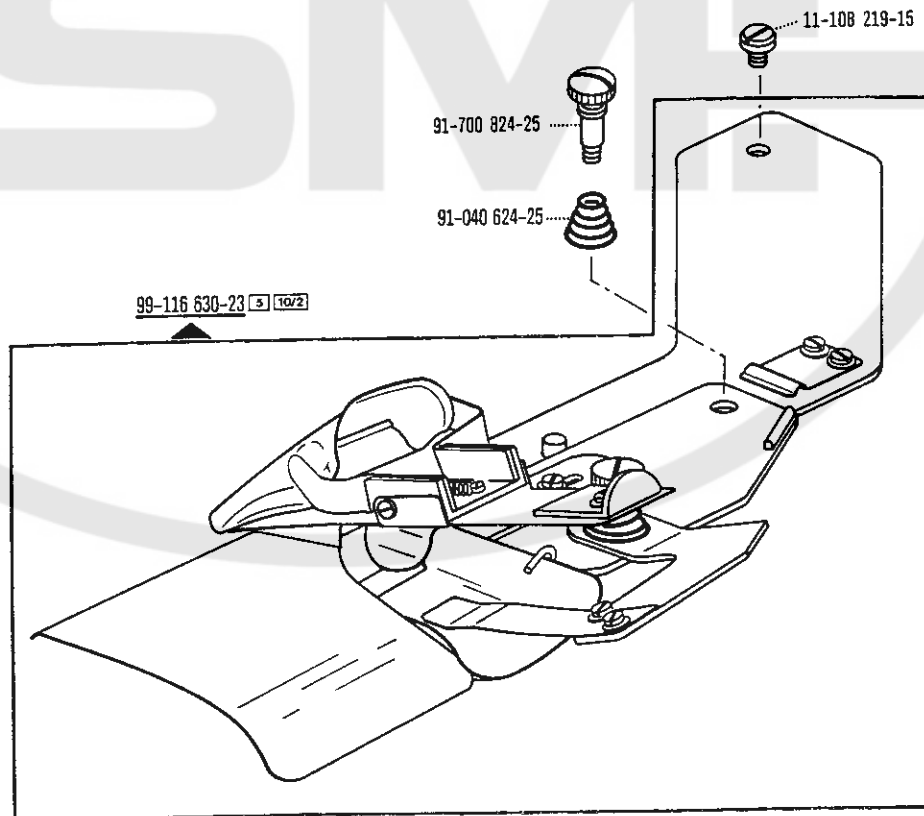

-68/99 (-900/..)

Nähwerkzeuge  
Gauge parts

Organes de couture  
Organos de costura

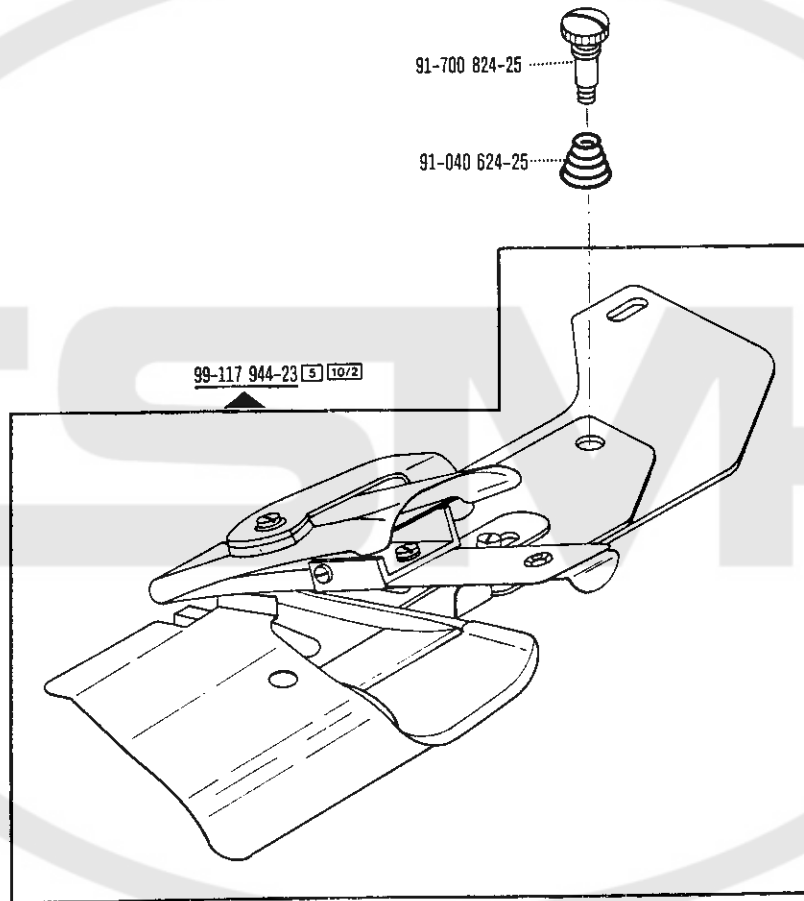

-68/97 (-900/..)

Nähwerkzeuge  
Gauge parts

Organes de couture  
Organos de costura

91-753 936-90

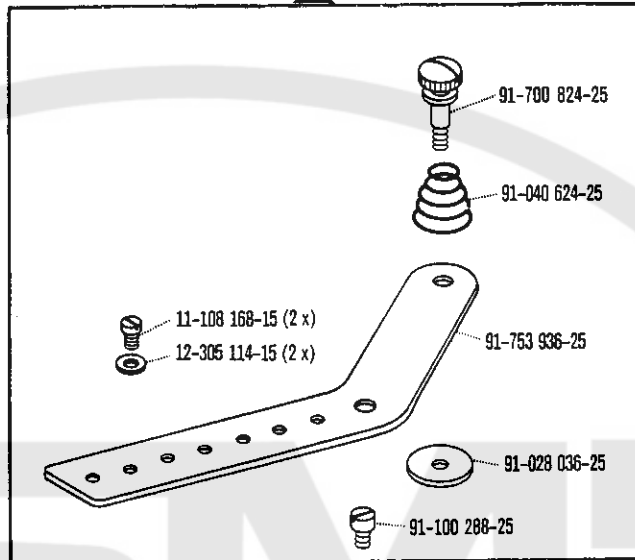

-147/02 (-900/..)  
-148/02 (-900/..)

11-130 173-15 (2 x)

91-057 707-91 10/2

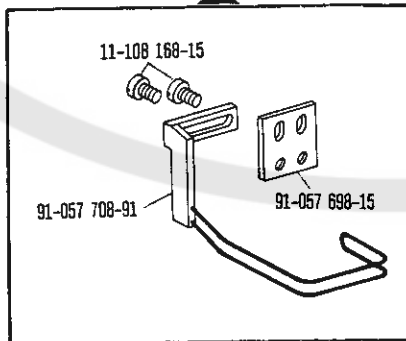

10 = 4,8 - 15,2 mm

-6/01 (-900/..)  
-6/07 (-900/..)  
-57/01 (-900/..)  
-58/01 (-900/..)  
-147/02 (-900/..)  
-148/02 (-900/..)

11-130 173-15 (2 x)

91-057 710-91 10/2

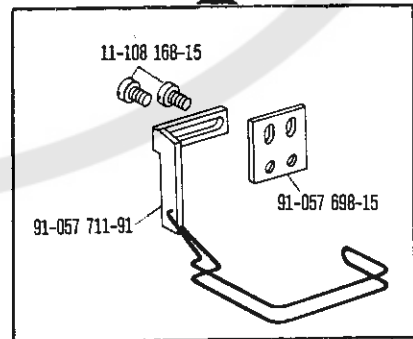

10 = 16,0 - 30,0 mm

-6/01 (-900/..)  
-6/07 (-900/..)  
-57/01 (-900/..)  
-58/01 (-900/..)  
-147/02 (-900/..)  
-148/02 (-900/..)

Nähwerkzeuge  
Gauge parts

Organes de couture  
Organos de costura

11-130 173-15 (2 x)



91-057 712-91 (10/2)

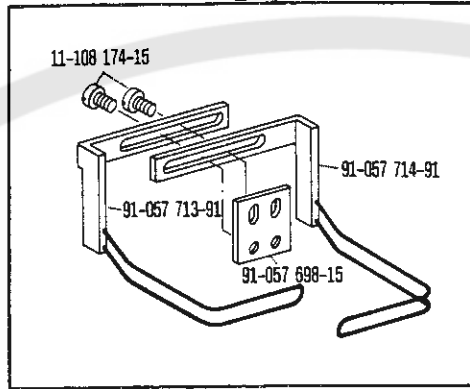

□ = 32,0 - 34,0 mm

11-130 173-15 (2 x)



91-155 422-91 (10/2)

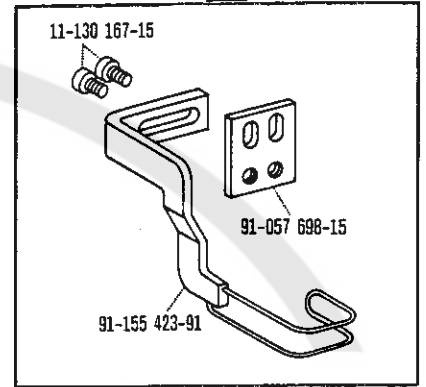

□ = 2,4 - 4,4 mm

-6/01 (-900/..)

-6/01 (-  
-6/07 (-

11-130 173-15 (2 x)



91-155 429-91 (10/2)

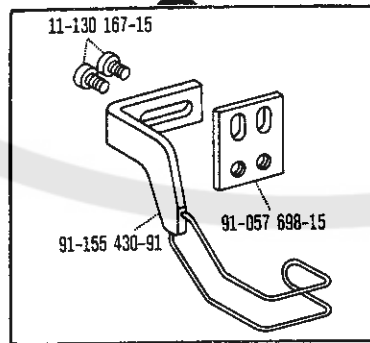

□ = 4,0 - 6,4 mm

-147/02 (-900/..)

-148/02 (-900/..)